

Muting Controller Box Installation and Operating Instructions



Important User Information





Because of the variety of uses for the products described in this publication, those responsible for the application and use of this control equipment must satisfy themselves that all necessary steps have been taken to assure that each application and use meets all performance and safety requirements, including any applicable laws, regulations, codes and standards.

The illustrations, charts, sample programs and layout examples shown in the guide are intended solely for purposes of example. Since there are many variables and requirements associated with any particular installation, Rockwell Automation does not assume responsibility or liability (to include intellectual property liability) for actual use based upon the examples shown in this publication.

Rockwell Automation publication SGI-1.1, Safety Guidelines for the Application, Installation and Maintenance of Solid-State Control (available from your local Rockwell Automation sales office), describes some important differences between solid-state equipment and electromechanical devices that should be taken into consideration when applying products such as those described in this publication.

Reproduction of the contents of this copyrighted publication, in whole or part, without written permission of Rockwell Automation, is prohibited.

Throughout this manual we use notes to make you aware of safety considerations:

<p>WARNING</p> 	<p>Identifies information about practices or circumstances that can cause an explosion in a hazardous environment, which may lead to personal injury or death, property damage, or economic loss.</p>
<p>IMPORTANT</p>	<p>Identifies information that is critical for successful application and understanding of the product.</p>
<p>ATTENTION</p> 	<p>Identifies information about practices or circumstances that can lead to personal injury or death, property damage, or economic loss. Attentions help you identify a hazard, avoid a hazard, and recognize the consequences.</p>
<p>SHOCK HAZARD</p> 	<p>Labels may be on or inside the equipment (for example, drive or motor) to alert people that dangerous voltage may be present.</p>
<p>BURN HAZARD</p> 	<p>Labels may be on or inside the equipment (for example, drive or motor) to alert people that surfaces may reach dangerous temperatures.</p>

It is recommended that you save this user manual for future use.

Contents

Reference Documents	3
Introduction	4
Wiring	5
Operating	9
Muting Types	12
Configuration and Diagnostic Tool	14
Indication	16
Installation	18
Mounting Stand	19
Adjustment	22
Trouble Shooting	24
Application Restrictions	24
Technical Data	25
Certifications and Conformity	26

Reference Documents

- GuardShield User Manual
- MSR42 Control Module User Manual
- GuardShield Safe 4 Safety Light Curtains User Manual
- GuardShield Micro 400 Safety Light Curtains User Manual
- MSR42 Configuration and Diagnostic Tool User Manual
- Installation Instruction Mounting Column
- User manual for any other safety device being connected to the muting controller box

Introduction

The Rockwell Automation Guardmaster muting controller box is a pre-wired enclosure using an MSR42 multi-function control module as the muting control module. This muting enclosure has pre-wired M12 quick-disconnect connectors to accommodate the connection of the Safe2/Safe4, Micro 400, or GuardShield POC and PAC safety light curtains. It also has pre-wired quick-disconnect connectors to connect up to four Rockwell 42EF, 42JS, or other Rockwell sensors as well as an M8 quick-disconnect connector for a muting lamp.

ATTENTION



The GuardShield Type 2 and Safe 2 light curtains may be used with the muting controller. However, the use of Type 2 devices with Category 4 devices does not improve the safety level of the safety circuit above a Category 2. Make sure that a risk assessment determines that a Category 2/Type 2 level of safety is sufficient for the application.

The Rockwell Automation Guardmaster muting box is supplied with flat brackets to mount this enclosure to a solid, flat surface or to the Rockwell Automation aluminum two meter floor mounting stand (445L-AMSTD2M). This floor mounting stand is designed for one or two 500 mm aluminum posts (445L-AMSTDMUT) to be cantilevered to each side of the vertical floor stand allowing for two or four muting sensors to be connected and positioned along their length. This mounting stand with one cantilever post is best for two sensor "L" type muting applications and a two cantilever post configuration is best suited for two or four sensor "T" type muting. Both "L" and "T" configurations are best suited for conveyORIZED muting applications.

The MSR42 multi-function safety control module allows up to four sensor muting, if the Micro 400 safety light curtain is used. Or for two sensor muting if the Safe 2/Safe 4 or GuardShield safety light curtains are used.

The Rockwell Automation muting control box is designed in accordance with the technical specification TS/IEC 62046.

The Rockwell Automation muting control box is factory configured for two sensor muting using a Safe 2, Safe 4, or GuardShield safety light curtain. Other muting configurations or safety light curtains will require the reprogramming of the MSR42 muting control module using the optical interface (445L-AF6150).

The factory default configuration of the MSR42 muting control module is as follows:

- Two sensor "T" type muting
- Without monitored muting lamp
- With manual start mode
- Without EDM

Mute dependant override is active and configured as follows:

$T_{(mdo)}$ is 60 seconds

Configured muting times

$t_{(sens)}$ is 4 seconds

$t_{(mute)}$ is 5 minutes

$t_{(msdel)}$ is 50 ms

The response time of the factory configured muting box is 17.30 ms.

Muting is indicated by the illumination of a white lamp on the front cover of the muting box or an external muting lamp may be connected to an M8 pico quick-disconnect connector located on the bottom of the muting box.

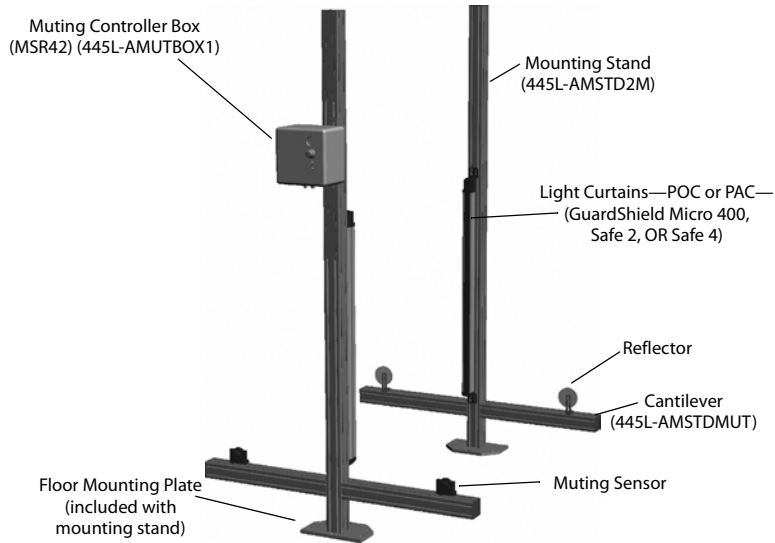

Figure 1: Muting System

Wiring

Connect muting components, power and output according to the corresponding muting type picture below.

Two Sensor Muting with Safe 4

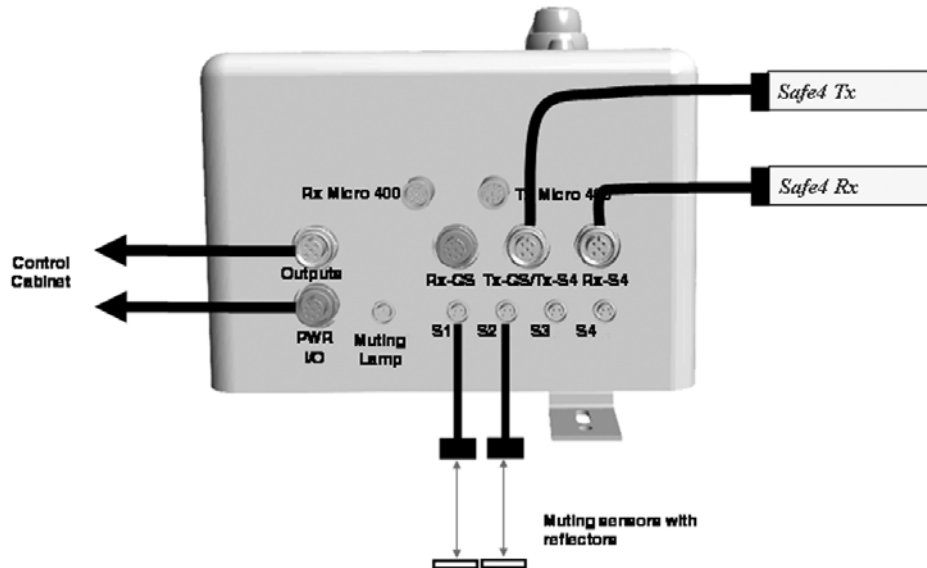

Figure 2: Wiring two sensor muting (T-Type or L-Type) with GuardShield Safe 4.

Four Sensor Muting with GuardShield Micro 400

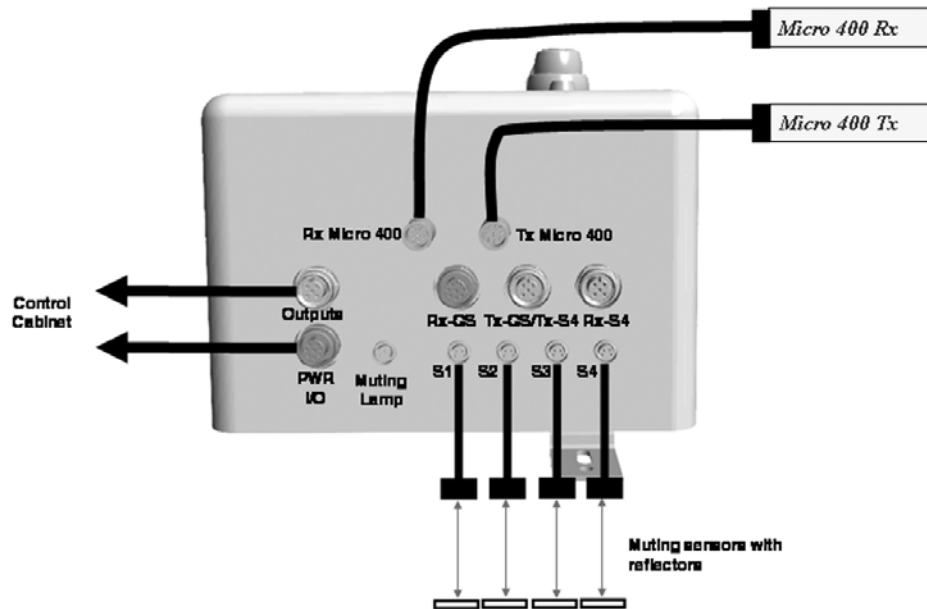

Figure 3: Wiring four sensor muting (T-Type) with GuardShield Micro 400

<p>ATTENTION</p>	<p>If connecting the Micro 400 to the muting box, the configuration of the MSR42 has to be changed according to the Software and Optical Interface section on page 14.</p>
<p>ATTENTION</p>	<p>It is necessary to use the original shielded Micro 400 patchcords (445L-AC8PCX (X is 1, 2, 3, 5, or 8 m)) to connect the Micro 400 transmitter and receiver to the muting controller.</p> <p>Not using these cables may cause a safety risk.</p>

Two Sensor Muting with GuardShield 440L

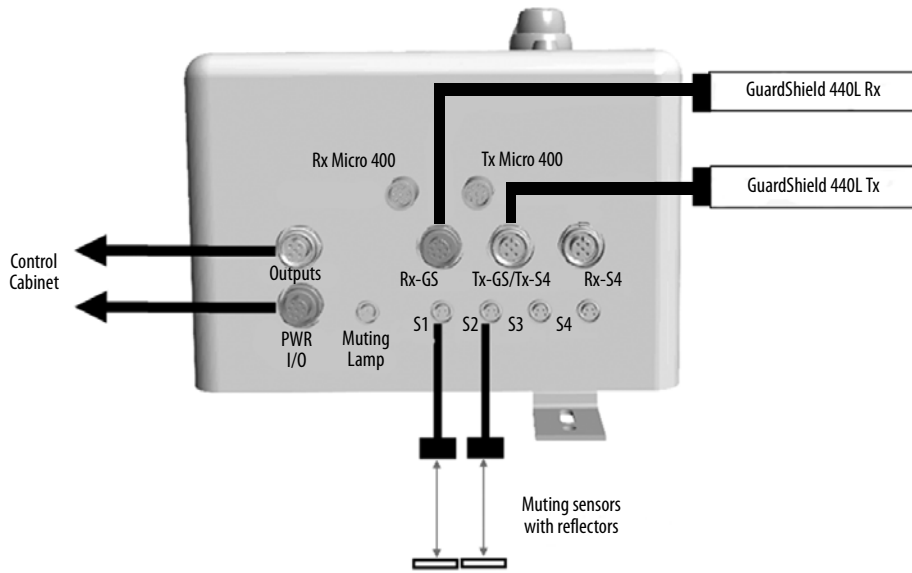

Figure 4: Wiring two sensor muting (T-Type or L-Type) with GuardShield 440L

<p>ATTENTION</p>	<p>When using other safety devices in a muting system, the configuration of the MSR42 must be changed according to the Software and Optical Interface section on page 14.</p>
-------------------------	---

Muting of Laser Scanners or Other Safety Sensors

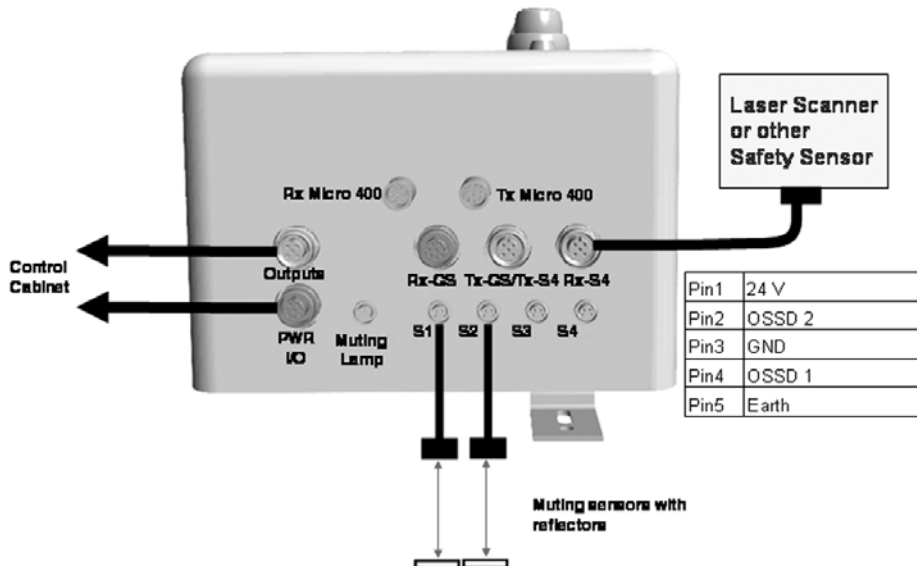

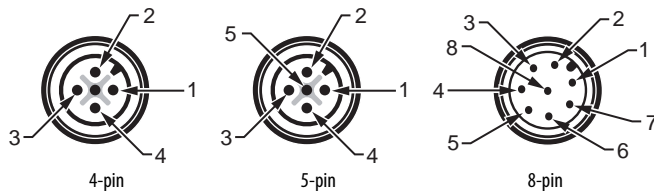

Figure 5: Two sensor muting of a laser scanner or other safety devices with PNP output

<p>ATTENTION</p> 	<p>When using other safety devices in a muting system, the MSR42 configuration must be changed according to the Software and Optical Interface section on page 14.</p>
---	--

Pin Assignment



Assignment	MSR42 Signal	Cordset 889D-F8AB-x
Pin1	Status Safety Output	Info1
Pin2	24V	24V
Pin3	Earth	Earth
Pin4	Status Lockout	Info2
Pin5	OSSD1	OSSD1
Pin6	OSSD2	OSSD2
Pin7	GND	GND
Pin8	Start	In1 (Start)

Table 1: Connector power (PWR/IO)

Assignment	MSR42 Signal	Patchcord 889D-M5AC-x
Pin1		Brown
Pin2		White
Pin3		Blue
Pin4		Black
Pin5	EDM - Start Release	In 2

Table 2: Connector Outputs

Assignment	MSR42 Signal
Pin 1	24V
Pin 2	Lamp
Pin 3	NC
Pin 4	NC

Table 3: Connector Muting Lamp

Assignment	MSR42 Signal
Pin 1	24V
Pin 2	DO
Pin 3	GND
Pin 4	LO

Table 4: Connector muting sensor S1 (S2, S3, and S4)

Assignment	MSR42 Signal
Pin1	24V
Pin2	Test
Pin3	GND
Pin4	Test
Pin5	Earth

Table 5: Connect GuardShield 440L or Safe 2 or Safe 4 transmitter (Tx-GS/Tx-S4)

Assignment	MSR42 Signal
Pin1	24V
Pin2	OSSD 2
Pin3	GND
Pin4	OSSD 1
Pin5	Earth

Table 6: Connector GuardShield Safe 2 or Safe 4 receiver (Rx-S4)

Assignment	MSR42 Signal
Pin1	NC
Pin2	24V
Pin3	Earth
Pin4	NC
Pin5	OSSD 1
Pin6	OSSD 2
Pin7	GND
Pin8	NC

Table 7: Connector GuardShield 440L receiver (Rx-GS)

Assignment	MSR42 Signal
Pin 1	Tx-1
Pin 2	Tx-2
Pin 3	Tx-3
Pin 4	Tx-4
Pin 5	Tx-5
Pin 6	Tx-6
Pin 7	Tx-7
Pin 8	Tx-8

Table 8: Connector GuardShield Micro 400 transmitter (Tx Micro 400)

Assignment	MSR42 Signal
Pin 1	Rx-1
Pin 2	Rx-2
Pin 3	Rx-3
Pin 4	Rx-4
Pin 5	Rx-5
Pin 6	Rx-6
Pin 7	Rx-7
Pin 8	Rx-8

Table 9: Connector GuardShield Micro 400 receiver (Rx Micro 400)

Muting Lamp

The muting lamp warns an operator in the event that the light curtain is muted. Depending on the risk analysis, often a muting lamp, monitored by the MSR42 control unit (controller box), signals the muting procedure. The size and the brightness of the connected lamp must also be designed as required by the safety analysis.

By default the muting lamp is not monitored in the muting controller box. However, the muting lamp must be used (reference the MSR42 user manual for further information). To change the muting lamp to monitored, reference the "Configuration and Diagnostic Tool" user manual.

If an error in the muting sequence has occurred, the muting lamp will blink (ca. 1 Hz), indicating that the muting condition has not been initiated, or has been discontinued.

The plug "muting lamp" offers to connect an additional muting lamp to the controller box.

Muting Lamp	Meaning
Off	Safety light curtain active
On	Light curtain muted
Flashing	Error in muting sequence

Table 14: Muting lamp

Operating

The control of the muting is done with one spring return switch called Reset/Override. It triggers the start input of the MSR42 controller. The control signal on the Quick-QD M12 connector "PWR I/O" – Pin 8 (Start) works in parallel to the key switch.

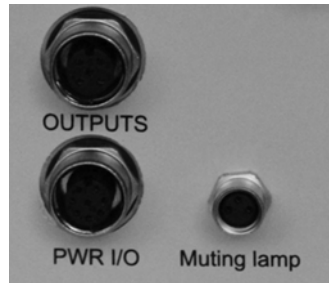
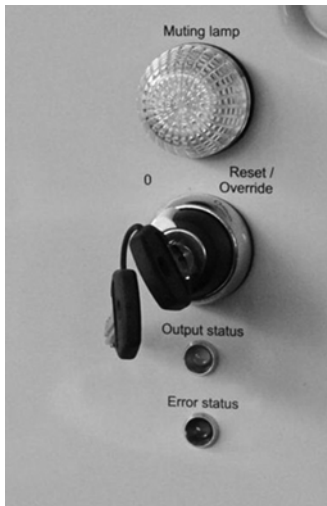

Key Switch, Reset/Override

- Turn right (impulse) Reset
- Turn right (impulse) Mute dependent override
- Turn right (10 sec) Power restart

Reset/override key switch on muting box is identical with the start signal from connector, PWR I/O — Pin 8 (Start)

ATTENTION



Before restarting the muting operation, make sure all personnel are out of the hazardous area.

Reset

The reset function switches on the OSSD safety outputs consider the safety light curtain is uninterrupted.

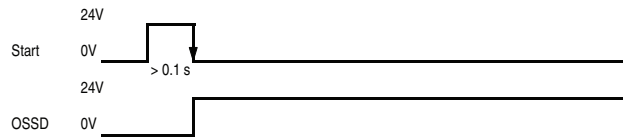

Figure 16: Reset function

Mute Dependent Override

An error in the muting signal sequence will discontinue the muting condition. If the safety light curtain is then interrupted the OSSD outputs will switch off. This normally leads to a stoppage of the movement of the material. The muting lamp will flash.

For moving the material out of the protective field area in this situation (protective field interrupted), the start signal triggers the mute dependant override function.

<div data-bbox="159 726 295 758" data-label="Section-Header"> <p>ATTENTION</p> </div> <div data-bbox="178 768 276 856" data-label="Image"> </div>	<p>The maximum activation time $t(mdo)^a$ for this override function is set to one minute by default. This time has to be considered on risk analysis of the application.</p> <p>The "Reset/Override" switch has to be mounted at a location, where the dangerous area can be overseen.</p> <p>The mute dependant override function is automatically terminated after the mute dependant override time $t(mdo)$ has elapsed, or when the safety light curtain is no longer interrupted.</p>
--	---

a. Mute dependent override time

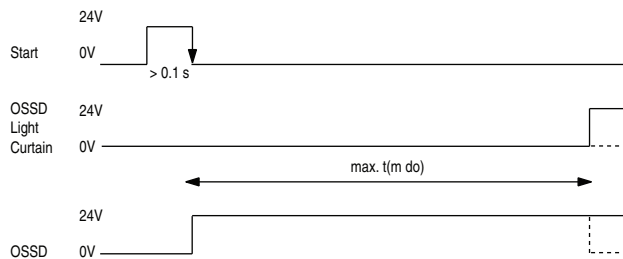

Figure 17: Mute dependent override function

Lockout and Restart

The following fault conditions will lead to a lockout:

- The connection to the Micro 400 safety light curtain emitter or receiver is interrupted.
- Defect in the electronics of Micro 400 light curtain or the MSR42 controller.
- Supply over- or undervoltage
- Error in EDM

A lockout is indicated with LED "Error Status" (= off) and with the output signal "Lockout" of connector "PWR/IO" (Pin 4). On the Micro 400 light curtain it is indicated with the red blinking LED (emitter and receiver).

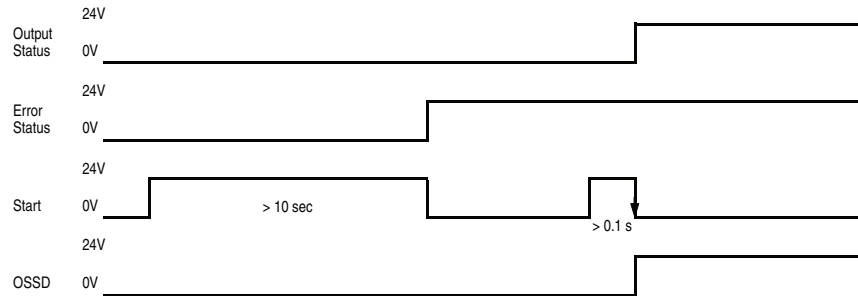

Figure 18: Power-up function

The lockout mode may be reset by one of two methods:

- Power down, then Power up. If the fault is still present the module will lockout again.
- A start signal on switch “Reset/Override”
- A start signal on connector “PWR I/O” Pin 4

Assuming the cause of the lockout has been eliminated (from activating the “Reset/Override” switch for ten seconds), the controller starts up. If the safety light curtain is interrupted, e.g. due a pallet, the controller goes into a safe off mode. The “Reset/Override” switch has to be reactivated again to start the mute-dependent-override function (see Figure 18).

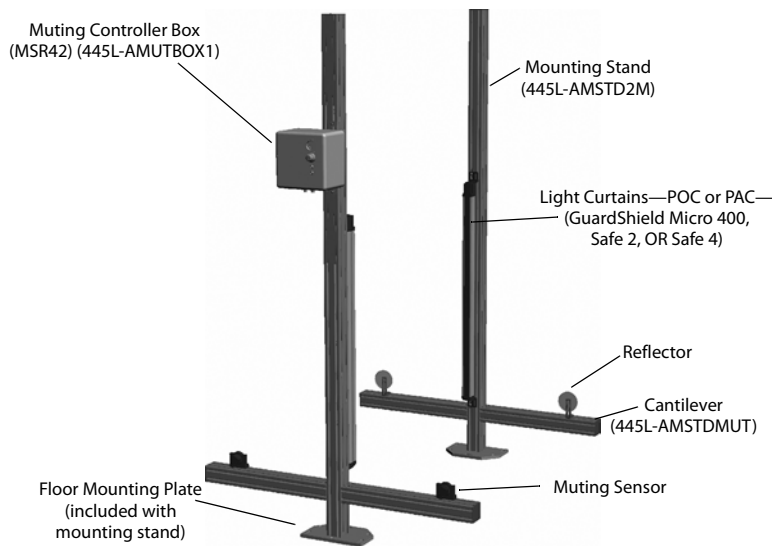

Figure 19: Muting System

Muting Types

The international standard IEC 62046 describes two- and four-sensor T- and L-type muting. The sensor positions recommended below are taken from IEC62046 and IEC61496 (A.7). The light curtain should detect the material, not the carrier (pallet).

T-Type 2 Sensor

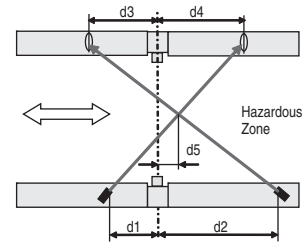
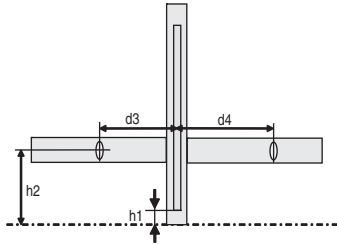

Figure 20: The distance d5 should be as short as practicable in order to avoid persons entering the hazardous zone without being detected when following immediately after the pallet or the transport system. The muting beam cross point has to be in the hazardous zone.

- h1: Lower height of safety protective field
- h2: Muting sensor height

$h2 \geq h1$

- d1, d2, Distance light curtain — muting sensor
- d3, d4: Muting sensor reflectors

The distances d1, d2, d3 and d4 has to be selected, that the difference in timing is > 50 ms.
 $h2 > h1$

d5: distance from the safety light curtain to the muting sensor crossing point.

T-Type 4 Sensor

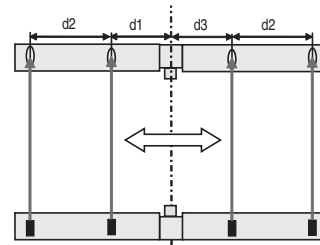
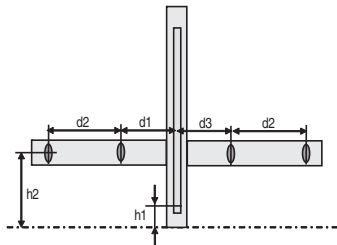

- h1: Lowest beam of safety light curtain
- h2: Muting sensor height
- d1: Distance light curtain — muting sensor
- d3: Distance light curtain — muting sensor
- d2: Distance muting curtain — muting sensor

Recommended mounting position according to IEC 62046 F.2:
 $d1 < 200$ mm
 $d3 < 200$ mm
 $d2 > 250$ mm

L-Type 2 Sensor



- h1: Lowest beam of safety light curtain
- h2: Muting sensor height
- d1: Distance light curtain — muting sensor
- d2: Distance muting sensor — muting sensor

- Recommended mounting position according to IEC 62046 F.2:
- $d1 < 200 \text{ mm}$
 - $d2 > 250 \text{ mm}$
 - $h2 \geq h1$

Muting Function

Moving goods (e.g. pallet) through the muting station leads to the timing diagram of the left picture below. During the mute time [t(mute)] the muting lamp is lit. Muting sensor S1 and muting sensor S2 must have a timing delay of at least >50 ms.

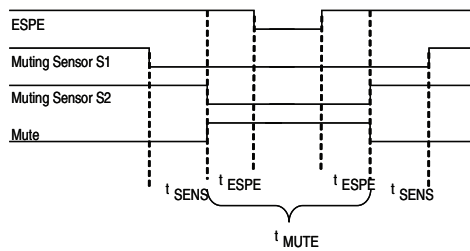

Timing for 2 Sensor T-type (standard factory supplied configuration)

Configuration and Diagnostic Tool

Software and Optical Interface

The default configuration is set for two beam T-Type muting of a GuardShield Safe 2 or Safe 4 (445L) or a GuardShield (440L) safety light curtain.

Other muting types can be selected with the configuration and diagnostic tool software and downloaded with the optical interface (445L-AF6150). The software and manual are supplied with the optical interface or are available on www.ab.com (Product MSR42).

	Muting Type				Safety Light Curtain				Muting Sensor			Comments
	2 Beam, T-type	2 Beam, L-type	4 Beam, T-Type	2 Beam, T-Type wEnable	GS Safe 2 or Safe 4	GS Micro 400	GuardShield (440L)	Other Safety Sensor	Right-Sight	VisiSight	Other	
Default	√				√		√	√	√	√	√	Default Setting
Selectable		√			√	√	√	√	√	√	√	Configurable with MSR42 safety software & download with optical interface
Selectable			√		*	√	*	*	√	√	√	
Selectable				√	*	√	*	*	√	√	√	

Table 24: Setting for the MSR42 muting controller

	Inputs		Outputs		Safety	
	IN1	IN2	Info1	Info2	Stop delay	External Device Monitor (EDM)
Default	Start	None	Safety Output	Lockout	No	No
Selectable	Test Input	Start EDM Start Release	See MSR42 Safety Software	See MSR42 Safety Software	<120s	EDM Start Release

Table 25: Settings for the muting controller (MSR42)

	Additional Settings				Time Settings				
	M-Lamp Monitored	Mute Depend. Override Active	Muted Light Curtain	Light Curtain Interrupt. Monitored	t (sens)	t (espe)	t (mute)	t (mdo)	t (msdel)
Default	no	yes	OSSD	yes	4 s	5 s	5 min	60 s	0.05 s
Selectable	yes/no	yes/no	OSSD GuardShield Micro 400	yes/no	See MSR42 configuration manual				

Table 26: Settings for the MSR42 muting controller

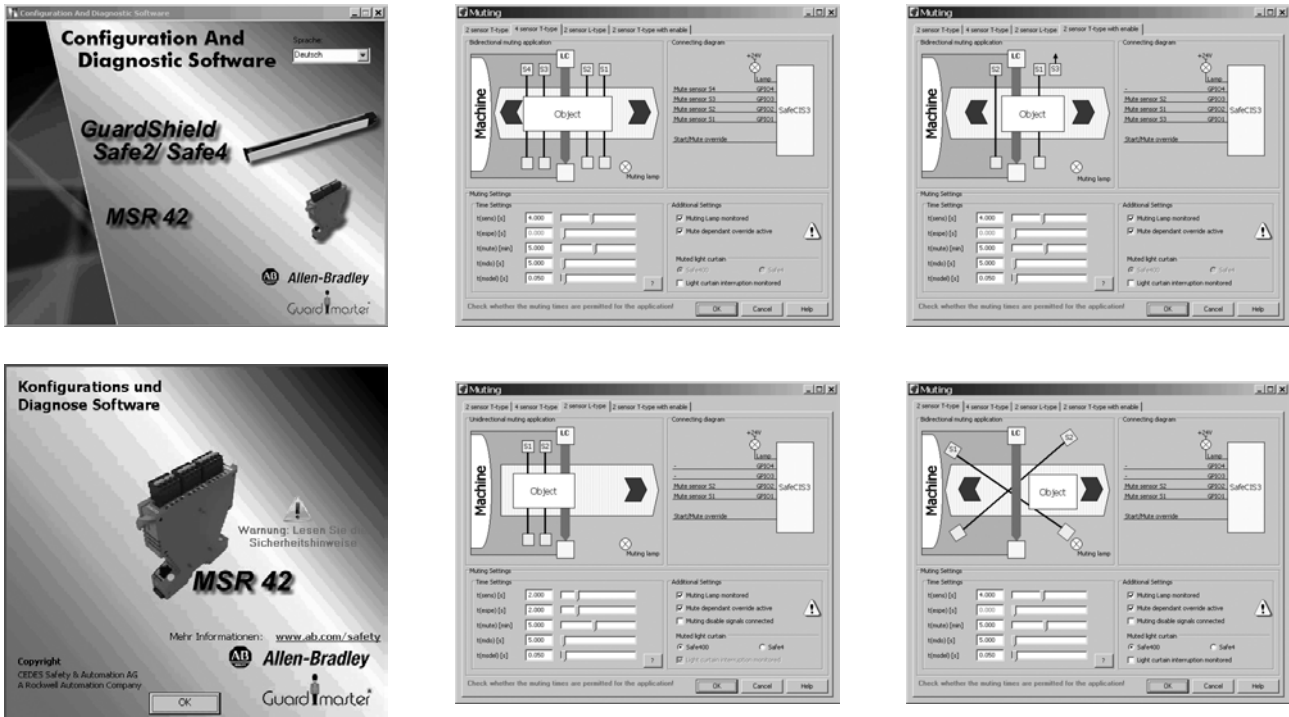
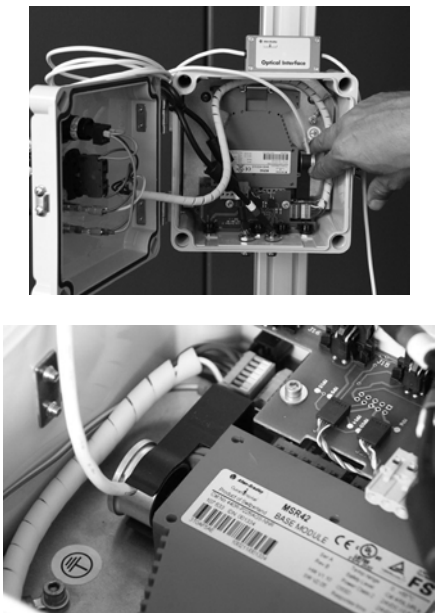

Table 27: MSR42 configuration and diagnostic software

Download with Optical Interface



In case the default configuration (see above) will not be used, the created configuration has to be downloaded with the optical interface (445L-AF6150); connected to the MSR42 control module.

- Clip the suction head cap into the black fastener
- Connect the USB plug into your computer
- Start the configuration software
- Create the desired configuration. Reference the “Configuration and Diagnostic Tool” user manual.
- Download the configuration (Menu File – download)

Indication

Safety Light Curtain

The green LED on the receiver light curtain indicates under normal operation if the protective field is uninterrupted. See corresponding light curtain manual.

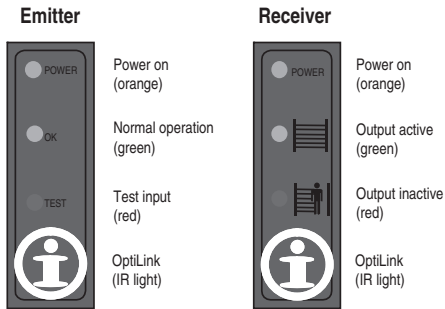

GuardShield Safe 4, GuardShield Safe 2

Emitter	LED = green on	Normal operation
Receiver	LED = green on	Protective field is uninterrupted
	LED = red on	Protective field is interrupted.

GuardShield Micro 400

LED = green on	Protective field is uninterrupted
LED = red on	Protective field is interrupted.
LED = Flashing red	Lock out condition
LED = Flashing green	Low light intensity

Note: If the LED is flashing green, optimal alignment has not been attained. Continue adjusting the Micro 400 until a solid green LED is visible.

Muting Sensor



Check the sensor manual for LED indication.

The yellow LED on the RightSight sensor indicates correct alignment of an uninterrupted beam. If the orange LED is off, the intensity is too low and the beam should be readjusted.

Muting Box



Three indicators showing the condition of the muting box.

Muting lamp	off	Safety light curtain is active
	white on	Safety light curtain is muted
	white flashing	Muting sequence error
Output status	off	OSSD output = off
	green on	OSSD output = on
Error status	off	Lockout
	green on	ok

ATTENTION



The status output are driven from the MSR42 output info 1 and 2. The meaning of the indication can be changed according to the configuration downloaded for the MSR42 (see Software and Optical Interface section).

Muting System Examples

Product	Part Number	Description
Safe 4 PAC Light Curtain Example		
Light Curtain	1x 445L-P4S3400YD	Safe 4 PAC 3 beam light curtain pair
Muting Box	1x 445L-AMUTBOX1	Muting Controller Box (MSR42)
Light Curtain Patchcord	2x 889D-F5ACDM-1	5 conductor M12 patchcord 1 meter, also offered in 5 and 10 meter lengths (2 required)
Muting sensor	2x or 4x 42EF-P2MPB-Y4	RightSight, Polarized Retro, Red, DC - 2 Complementary LO/DO Outputs, (PNP), 4-pin Pico QD on 152 mm (6 in.) pigtail (2 or 4 sensors required) muting sensor patchcord
Muting sensor patchcord	2x or 4x 889P-F4ABPM-x	4 conductor M8 patchcord (x = 1, 2, 3, or 5 meter)
Muting sensor bracket	2x or 4x 60-2649	Swivel/Tilt Bracket for RightSight sensors 2x or 4x 889P-F4ABPM-1
Muting sensor reflector	2x or 4x 92-39	Reflector 76 mm (Bracket included in 445L-AMSTDMUT)
If external mute lamp is desired, a mute lamp option with right angle bracket is below		
Muting lamp with bracket	1x 855E-24TL7 855E-BVMC	Muting lamp with right angle bracket
Muting lamp patchcord	1x 889P-M4AB-5	4 conductor M8 Pico patchcord, 5 meters
Connection cable power (PWR/IO)	1x 889D-F8AC-x	x = 2, 5, or 10 meter
Connection cable outputs	1x 889D-M5AC-x	x = 2, 5, or 10 meter
GuardShield PAC Light Curtain Example		
Light Curtain	1x 440L-P4A3400YD	GuardShield PAC 3 beam light curtain pair
Muting Box	1x 445L-AMUTBOX1	Muting Controller Box (MSR42)
Light Curtain Patchcord	1x 889D-F4ACDM-1	Transmitter patchcord 1 m, Straight, DC Micro M12-4 conductor
Light Curtain Patchcord	1x 889D-F8ABDM-5	Receiver patchcord 5 m, Straight, DC Micro M12-5 conductor
Muting sensor	2x or 4x 42EF-P2MPB-Y4	RightSight, Polarized Retro, Red, DC - 2 Complementary LO/DO Outputs, (PNP), 4-pin Pico QD on 152 mm (6 in.) pigtail (2 or 4 sensors required) muting sensor patchcord
Muting sensor patchcord	2x or 4x 889P-F4ABPM-x	4 conductor M8 patchcord (x = 1, 2, 3, or 5 meter)
Muting sensor bracket	2x or 4x 60-2649	Swivel/Tilt Bracket for RightSight sensors muting sensor patchcord
Muting sensor reflector	2x or 4x 92-39	Reflector 76 mm (Bracket included in 445L-AMSTDMUT)
If external mute lamp is desired, one mute lamp option with right angle bracket is below		
Muting lamp with bracket	855E-24TL7 855E-BVMC	Muting lamp with right angle bracket
Muting lamp patchcord	889P-M4AB-5	4 conductor M8 Pico patchcord, 5 meters
Muting stand	2x 445L-AMSTD2M	
Muting cantilever	2x or 4x 445L-AMSTDMUT	
Micro 400 Light Curtain Example		
Light Curtain	1x 440L-P4E1200FP	30 mm Micro 400 light curtain pair, 1200 mm
Muting Box	1x 445L-AMUTBOX1	Muting Controller Box (MSR42)
Micro 400 patchcords	2x 445L-AC8PC1	8 pin M12 patchcord with filter, 1 meter, also offered in 3 meter and 5 meter lengths
Muting sensor	2x or 4x 42EF-P2MPB-Y4	RightSight, Polarized Retro, Red, DC - 2 Complementary LO/DO Outputs, (PNP), 4-pin Pico QD on 152 mm (6 in.) pigtail (2 or 4 sensors required) muting sensor patchcord
Muting sensor patchcord	2x or 4x 889P-F4ABPM-x	4 conductor M8 patchcord (x = 1, 2, 3, or 5 meter)
Muting sensor bracket	2x or 4x 60-2649	Swivel/Tilt Bracket for RightSight sensors muting sensor patchcord
Muting sensor reflector	2x or 4x 92-39	Reflector 76 mm (Bracket included in 445L-AMSTDMUT)

Muting System Examples (continued)

Product	Part Number	Description
If external mute lamp is desired, one mute lamp option with right angle bracket is below		
Muting lamp with bracket	1x 855E-24TL7 855E-BVMC	Muting lamp with right angle bracket
Muting lamp patchcord	1x 889P-M4AB-5	4 conductor M8 Pico patchcord, 5 meters
Optical interface	1x 445L-AF6150	Optical interface (can be reused for further configuration)

Installation

If mounting the Rockwell Automation Guardmaster muting box as a standalone muting box, it is best to locate this muting box adjacent to the muting sensors and safety light curtain. The enclosure may be mounted to a smooth flat surface by using the brackets supplied with the muting box.

It is also possible to mount the enclosure to the Rockwell Automation floor mounting stand (445L-AMSTD2M). This two meter stand kit comes with a aluminum floor plate, hardware, and Installation instructions. Depending upon the muting system design, it may be necessary to purchase one or two 500 mm aluminum post kits (445L-AMSTDMUT) that are designed to be cantilevered from the side of the vertically mounted floor stand.

Mounting hardware (T-nuts, and screws) are included in the two meter stand and 500 mm post kits to mount the muting sensor, light curtain and muting box¹.

Mounting of the Muting Controller Box

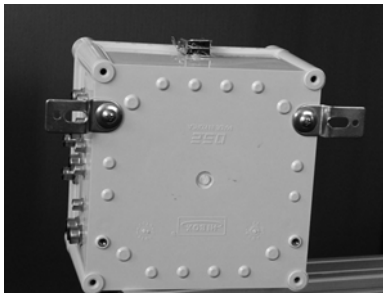

Mount the brackets on the muting box.

Tighten the screws properly.

Determine where on the mounting stand the muting box will be located.

Check for height position with respect to the cable wiring of the light curtain, muting sensors and muting lamp.

Connectors should be positioned on the bottom side of the muting box.

Premount the muting box with the T-slot nuts to the mounting column.

Do not tighten the screws until the box is in right position.

Tighten the screws alternately.

1. T-nuts and screws for:
Safety light curtain Safe4, Safe2, 445L-AF6145 for Micro 400, GuardShield 440L,
Muting sensor bracket 60-2649 (RightSight) and 92-39 Reflector
Muting box

Mounting Stand

Mounting Column (basic instructions, see installation instructions supplied with 445L-AMSTD2M kit)

Step 1: Assemble floor plate to two meter post.

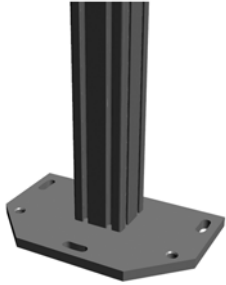

Mount the mounting column onto the floor plate.

See mounting stand installation instruction

Check for front side positioning of the column (see picture). Check the sliding nuts position for light curtain, sensor bar, and controller box.

Step 2: Attach muting sensor post(s) according to desired muting type

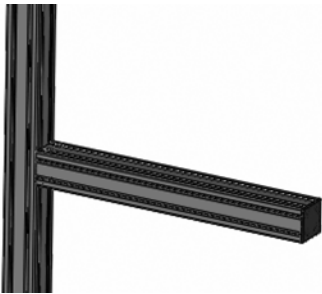

Attach bars (e.g., two sensor muting)

Step 3: Attaching light curtain brackets

GuardShield Safe 2/Safe 4



T-slot nut and screws are included with the floor mounting column.

The mounting brackets are included with the safety light curtain.

Premount the mounting kits on the T-slot



Before mounting the light curtain, check for height position and cable exit (bottom or top).

Step 4

GuardShield Micro 400

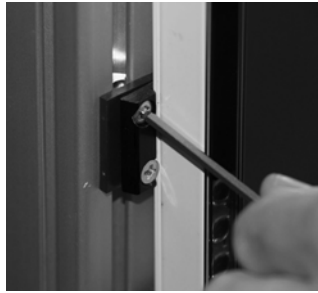

The Micro 400 light curtain is supplied with 180° adjustable mounting brackets. The flat mounting bracket kit (445L-AF6145) is sold separately. Before mounting, check for height and cable exit position (bottom or top).

The 180° adjustable mounting brackets are included with the safety light curtain. T-slot M4-nut and screws are included with the floor mounting column.

Premount the brackets to the Micro 400 profile.

Attach Micro 400 brackets to the post slots using T-nuts provided.

GuardShield Micro 400 Profile Reinforced (specialty light curtains)



The GuardShield Micro 400 reinforced profile uses the same mounting brackets (445L-AF6140) as the GuardShield Safe 4. They are supplied with the light curtain.

T-slot nuts and screws are included with the floor mounting column.

Before mounting, check for height and cable exit position (bottom or top).

GuardShield Type 2/Type 4 (440L)



The mounting brackets for the GuardShield 440L are supplied with the light curtain.

T-slot nut and screws are included with the floor mounting column.

Before mounting, check for height and cable exit position (bottom or top).

Premount the bracket

Premount the light curtain with the supported screws.

Tighten the screws after aligning.

Note: Only one slot of the GuardShield bracket will fit into the mounting stand channel.

Step 4

Mounting of the Muting Sensors

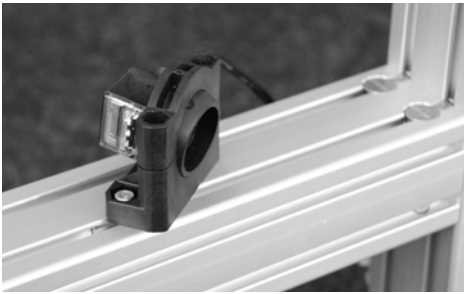

Before starting to mount the muting sensors, check the section for the mounting position with respect to the muting type. Mount the muting sensor according to its instruction.

T-slot nut and screws for the RightSight bracket 60-2649 are supported with the cantilever.

Check for good visibility of the sensor indicator LEDs.

Step 5

Mounting of the Retroreflectors



Check the Muting Types section on page 12 for the mounting position for the chosen muting type.

T-slot nut and screws are provided with the cantilever.

Muting with GuardShield Micro 400

For muting a GuardShield Micro 400 safety light curtain use the safety software to create a configuration and download it to the MSR42 controller.

Two-Beam or Four-Beam Muting

The MSR42 offers two beam and four beam muting according to the Muting Types section (page 12). The controller box is delivered by default with the two-beam T-type muting. Other muting configurations can be selected with the safety software and downloaded with the optical interface.

Note: Four beam muting is only possible if the Micro 400 safety light curtain is used.

Adjustment

Step 6

Adjustment of the Safety Light Curtain

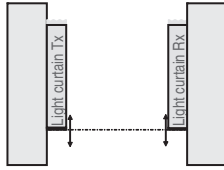

Position the emitter and receiver light curtain at the same height on the mounting column.

Fully tighten the light curtain mounting screws.

Step 7



General

First, adjust the horizontal angle of the floor mounting plate. Second, adjust the light curtain vertical axis (left-right) and vertical front-back-axis of the stand. However, the lighting of the green LED on the light curtain indicates that the protective field is uninterrupted and the light curtain aligned.

Premount the column with the floor mounting plate on the floor.

Adjust (with the floor plate adjustment screws) the position of the mounting column after mounting a light curtain.

When the light curtain indicates uninterrupted protective field, mount the mounting screws on the floor plate.

Adjustment of GuardShield Safe 4, Safe 2, or 440L GuardShield

Adjustment of the safety light curtain GuardShield Safe 4, GuardShield Safe 2, or GuardShield Type 2 or Bulletin 440L GuardShield:

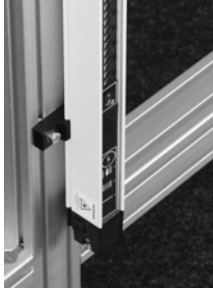

Use the integrated laser alignment system (ILAS) for easy verification. Touching the symbol  turns the laser on or off. The green indicator on the receiver light curtain confirms the correct alignment.

Step 8

Adjustment of the Light Curtain GuardShield Micro 400



The Micro 400 light curtain is best aligned by LED indicators. A green LED indicator on either the emitter or receiver light curtain confirms the correct alignment.

Adjustment of the Muting Sensors and Retroreflectors

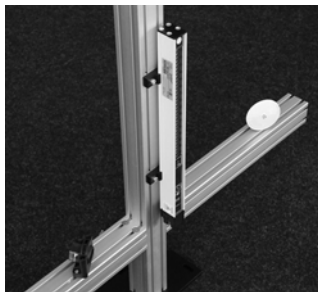

Note: The image shows the RightSight with reflector. Normally, the muting sensor gets mounted on one mounting bar and the reflectors on the other side.

For the corresponding muting type, check the Muting Types section on page 12 for sensor positions.

Tighten the cantilever screw when positioned at the correct height and the muting sensors are at the proper distance to the light curtain (see the Muting Types section on page 12).

Adjust the reflectors and muting sensors to each other. Check the status LEDs on the opto-retroreflective sensor for correct operation.

ATTENTION



- A pallet should not interrupt the light curtain nor the muting sensors. The light curtain and the muting sensors should be interrupted by the transported goods only.
- For a correct muting sequence, the muting sensors must be interrupted from the goods with a time difference of >50 ms.

Trouble Shooting

When the LED “Status Output” and “Status Error” are lit, the muting system is operating.

A simple functionality test can be performed interrupting each sensor for its own. Supposing that power is on, light curtain, muting sensors and the muting lamp are connected. The function of each sensor can be checked with the sensor LED indicator.

When considering correct operation of the light curtain and muting sensors, the muting lamp will flash when interrupting one muting sensor for a few seconds.

Check for the muting sequence according to Figure 3: Time for two sensor T-type.

Error Indications

Muting Lamp	Output Status	Error Status	Possible Reason	Possible Solution
off	on	on	Operating, safety light curtain active	
on	on	on	Operating, safety light curtain muted	
x	off	on	Operating, OSSD output off	Reset Make sure, that the safety light curtain and muting sensors are operating and uninterrupted
x	x	off	Lockout	Reset for ten seconds Check cables and connections of the light curtains See the Lockout and Restart in the Operating section on page 10.
flashing	on	on	Mute Sequence Error	Make sure, that the muting sensor and the safety light curtain are uninterrupted. Check alignment of the safety light curtain and muting sensors Clean the muting sensors and safety light curtain

Error in Sequence

If an error in the muting sequence has occurred, the muting lamp will blink (ca. 1 Hz), indicating that the muting condition will not be initiated, or has been discontinued.

Make sure, that the muting sensor and the safety light curtain are uninterrupted. Check alignment of the safety light curtain and muting sensors. Eventually the muting sensors and safety light curtain have to be cleaned.

Lockout

A non-illuminated LED “error status” indicates a lockout as described in the Software and Optical Interface section on page 14.

The reason for the lockout can be analyzed with the optical interface 445L-AF6150 and the safety software (see page 14).

Application Restrictions

The application is not intended for the following usage:

- In an explosive environment (EX),
- In radioactive areas or
- Outside of a temperature range of 0 ... 55°C.
- Operating range < 2.5 m
(depending on muting sensors and light curtain)

For further restrictions, see technical specification of the safety light curtain and MSR42 Safety Controller.

Technical Data

General data		
Temperature range	Environment temp.: 0...+55°C (32...131°F); Stock temp.: -25...+70°C (-13...158°F)	
Enclosure rating according EN 60529	IP65	
Net weight	MSR42	130 g
	Muting box	1.7 kg
	Cantilever floor mounting stand	5.7 kg
Housing dimensions	111 x 22,5 x 125 mm (incl. plugs)	
Certifications	According MSR42	
Interfaces	Optical Interface	
Weight and packaging		
Dispatch packaging	MSR42	280x 200 x 70 mm
	Muting box	300x 200x 200 mm
	Cantilever floor mounting stand	
Dispatch weight	MSR42	350 g
	Muting box	2.3 kg
	Cantilever floor mounting stand	6.5 kg
OSSD semi conductor outputs (PNP)		
Voltage	$U_N - 2 V$	
Current Max	400 mA short-circuit protected and with cross-fault detection	
Leakage current	$I_{MAX\ Off} \leq 0.1\ mA$ ($C_{LOAD} \leq 3.3\ \mu F$)	
Max. response time t(C) with U_N protective mode	$\leq 17.3\ ms$	
Output S1-S4 (MSR42 GPIO1 – GPIO4)		
Nominal voltage	$U_N - 2V$ (coded) (Short circuit protected)	
Current max	100 mA (short-circuit protected)	
Leakage current	$I_{MAX\ Off} \leq 0.05\ mA$ ($C_{LOAD} \leq 100\ nF$)	
Status Outputs (PNP), MSR42 Info 1, Info 2		
Voltage	$U_N - 2V$	
Current max	100 mA (short-circuit protected)	
Leakage current	$I_{MAX\ Off} \leq 0.05\ mA$ ($C_{LOAD} \leq 4.7\ \mu F$)	
Inputs (MSR42)		
Power supply U_N	+24V DC (EN 60204-1)	
at 5% residual ripple	0.85...1.15 U_N	
Current consumption	Nominal: 70 mA; Rush-In current: max 1.7 A	
Max. power consumption at max. supply voltage	2.1 W (semiconductor outputs unloaded)	
Controller protection (external)	5 A slow	
Control current into: IN 1, IN 2	2 mA each (min.) (in accordance with EN 61131-2)	
Minimum voltage at: IN 1, IN 2	11V DC at activated controller (EN 61131-2)	
Start pulse duration	Min.	50 ms
	Max.	5s
Mute sensor time delay	> 50 ms	
Test pulse duration (min.)	Response time x 2	
Control current into: GPIO1 – GPIO4	7 mA	
Safety Prevention Lamp	8 mA with lamp switched on	
Minimum current at Lamp	0.9 A with lamp switched on	
Safety Related Parameter		
Probability of a dangerous failure per hour PFH	9.0 E-10 1/h 3.0 E-10 1/h 4.0 E-9 1/h	MSR42 Main M. MSR45E GuardShield Micro 400

Certifications and Conformity

The Muting Station is based on the MSR42 Safety Controller. Relevant safety conformity and certifications may be found on the MSR42 and safety light curtain documentation.

Please contact us for Technical Assistance:

In the U.S.: 1-440-646-5800

Outside U.S.: 001-440-646-5800

Visit our website: www.ab.com/safety

www.rockwellautomation.com

Power, Control and Information Solutions Headquarters

Americas: Rockwell Automation, 1201 South Second Street, Milwaukee, WI 53204 USA, Tel: (1) 414.382.2000, Fax: (1) 414.382.4444

Europe/Middle East/Africa: Rockwell Automation, Vorstlaan/Boulevard du Souverain 36, 1170 Brussels, Belgium, Tel: (32) 2 663 0600, Fax (32) 2 663 0640

Asia Pacific: Rockwell Automation, Level 14, Core F, Cyberport 3, 100 Cyberport Road, Hong Kong, Tel: (852) 2887 4788, Fax: (852) 2508 1846

Publication 10000127397 Ver 01 July 2011

Copyright 2011 Rockwell Automation, Inc. All rights reserved.